

Fig. 1

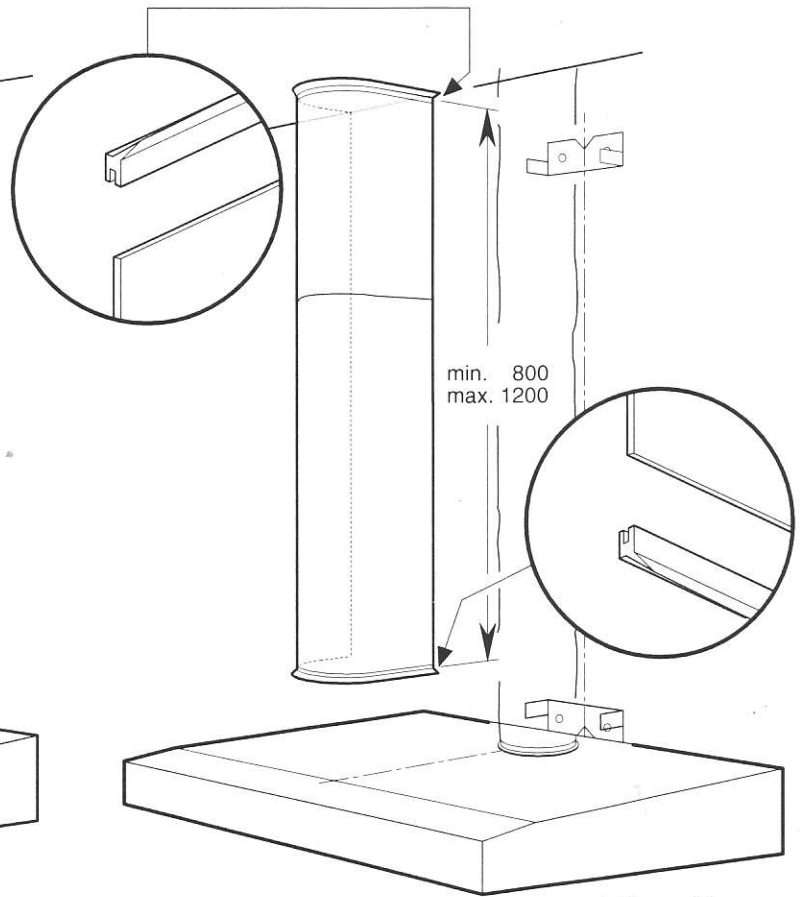

Fig. 2

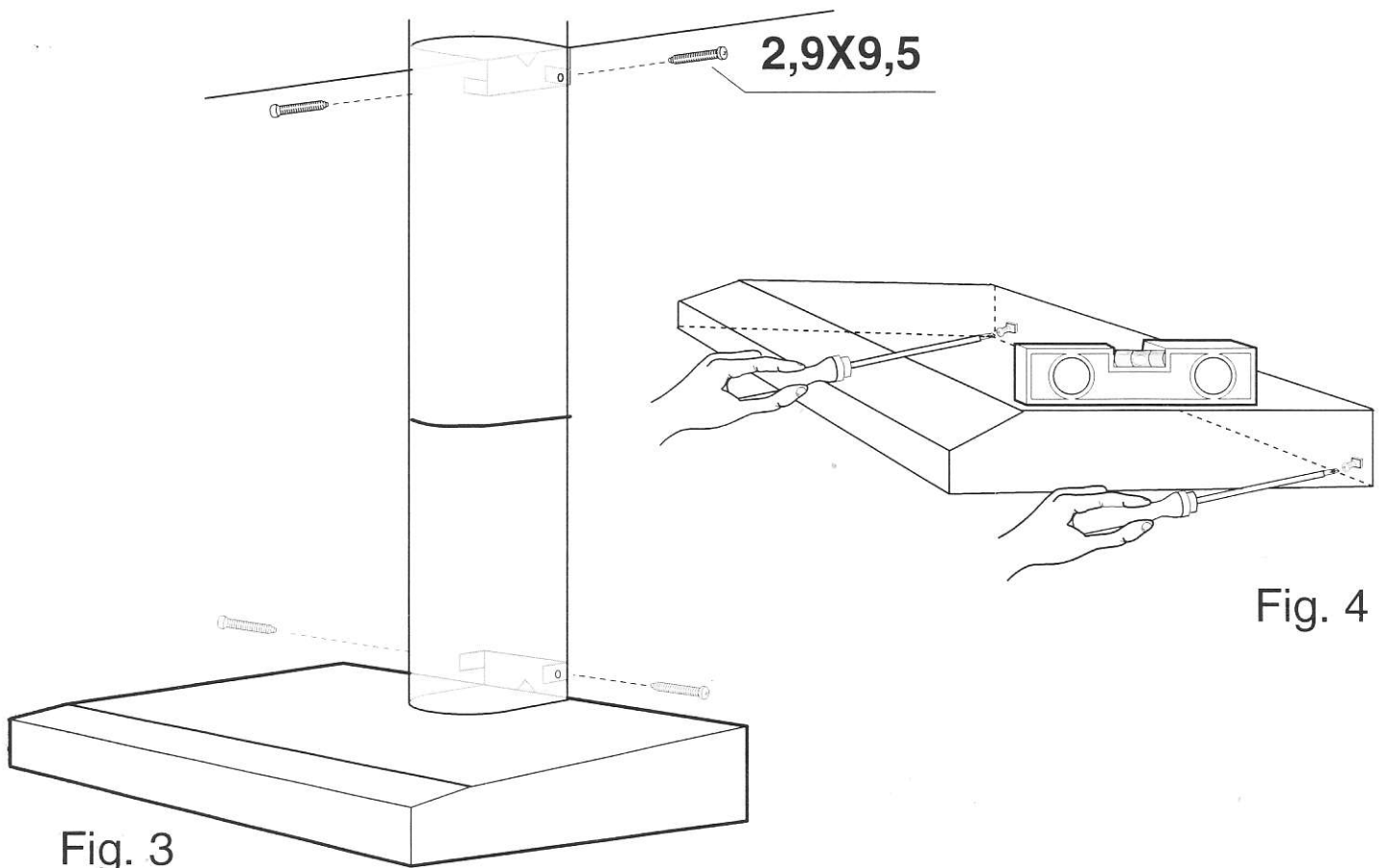

Fig. 4

Fig. 3